

## FSA9480 — USB 2.0 Accessory Switch

### Features

- Automatically Detects USB Accessories:
  - USB OTG Mode
  - CEA-936-A Car Kit and Chargers
  - Headsets
  - Video Cable
  - Factory Mode Cables
  - UART
  - TTY Converter
  - USB Data Cable
  - Chargers
- Auto-configures Connections with Independent Override Capability
- Integrated Audio Amplifier Generates Required Bias for CEA-936-A Car Kit Audio
- Automatic Low-Power Mode When No Accessory is Attached
- Integrated Over-Voltage and Over Current Protection FET on  $V_{BUS}$  for Fault Isolation
- Negative-Swing-Capable Audio Channel

### Applications

- Cell Phones

### Description

The FSA9480 is a USB port accessory detector and switch. The FSA9480 is fully controlled using I<sup>2</sup>C™ and enables USB data, stereo and mono audio, video, microphone, and UART data to use a common connector port. It is designed for compatibility with CEA-936-A car kit adapters, USB 2.0 signaling, and USB OTG (on-the-go). The architecture is designed to allow audio signals to swing below ground so a common USB and headphone jack can be used for personal media players and portable peripheral devices.

The FSA9480 meets USB specification Rev. 2.0, micro-USB specification, and CEA-936-A.

### Ordering Information

Part Number	Operating Temperature Range	Top Mark	Package
FSA9480UCX	-40 to +85°C	N4	25-Lead, 2.1x2.1x0.625mm WLCSP Package

I<sup>2</sup>C™ is a trademark of NXP B.V. Corporation.

Application Diagram

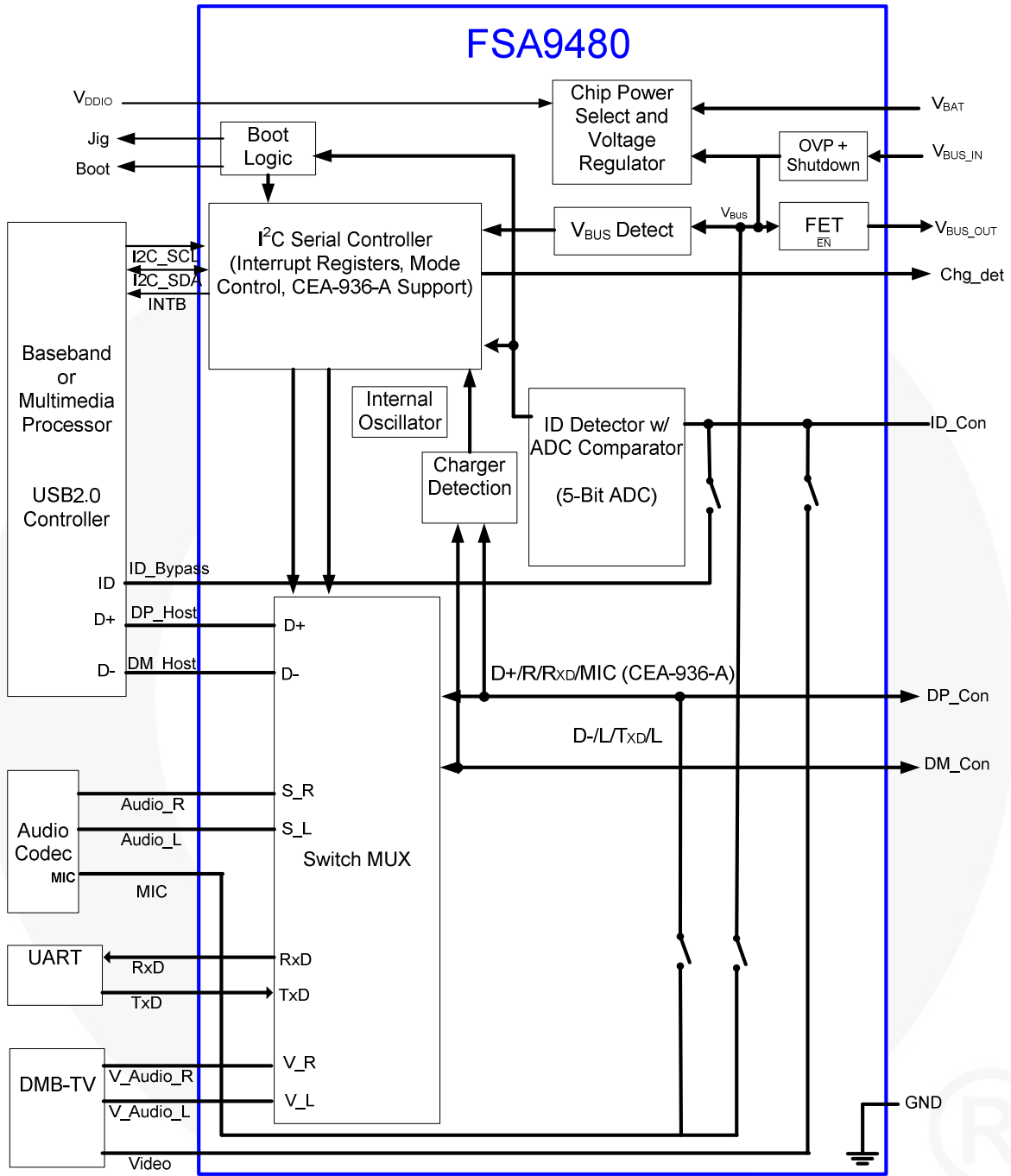

Figure 1. Typical Application

## Block Descriptions

This block is used for factory-mode test and debug as described in Table 1.

**Table 1. Boot Table**

Factory Mode	ID Resistor	JIG	BOOT	Switch Connections
UART, Boot Off	523K $\Omega$	LOW	LOW	Table 3 - Accessory Auto Configuration Table
USB, Boot On	301K $\Omega$	LOW	HIGH	Table 3 - Accessory Auto Configuration Table
USB, Boot Off	255K $\Omega$	LOW	LOW	Table 3 - Accessory Auto Configuration Table
UART, Boot On	619K $\Omega$	LOW	HIGH	Table 3 - Accessory Auto Configuration Table
No Factory Mode	N/A	Hi-Z	LOW	See Notes 1 and 2

### Notes:

1. JIG pin description: Low signals the phone to power up. When disabled this open drain floats and the pin is Hi-Z
2. BOOT pin description: This boot pin level directs the baseband processor which mode to boot in when the JIG box is attached, the JIG pin has been driven LOW, and the phone is powered up.

## D+, D- Charger Detection

This block monitors D+ and D- to determine when a USB charger or dedicated charger is attached to the phone. The detection scheme follows the dedicated charger-detect algorithm as defined in the USB Implementers Forum Battery Charging Working Group specification titled *Battery Charging Specification* and as described in the CEA-936-A USB car kit specification. The FSA9480 distinguishes between a dedicated charger and USB charger and reports the appropriate type in the Device Type 1 Register. Whenever either type of charger is detected, the CHG\_DET (I<sub>SET</sub>) pin is pulled LOW.

## Chip Power Select and Voltage Regulator

This block independently selects V<sub>BUS\_IN</sub> or V<sub>BAT</sub> to power the FSA9480 and includes necessary LDO voltage regulators to provide stable power.

Valid ranges (for detecting and accepting supply) for:

V<sub>BAT</sub>: 3.0V to 4.4V

V<sub>BUS</sub>: 4.4V to 5.5V.

Voltage reference selection criteria:

- If V<sub>BUS</sub> is present and in the valid range, the device takes its power from V<sub>BUS</sub>. Otherwise, the device takes its power from V<sub>BAT</sub> (if in valid range).
- If the device is operating on V<sub>BAT</sub> and a valid V<sub>BUS</sub> becomes available, the device switches to the V<sub>BUS</sub> reference.

This block also accepts a V<sub>DDIO</sub> voltage reference for baseband interface I/O signals.

## OVP / OCP Shutdown Block

When V<sub>BUS</sub> is less than 6.8V, this block allows the V<sub>BUS</sub> supply to enter the chip power select voltage regulator block. For V<sub>BUS</sub> greater than 7.2V, the input is disconnected, protecting the FSA9480 from excess voltage. This block is capable of withstanding continuous 28V in shutdown mode. Upon entering shutdown, the OVP\_EN bit in the Interrupt 1 Register is set HIGH and an interrupt is sent to the baseband. The Over-Current Protection (OCP) feature limits current through the charger FET to  $\leq 1.5A$  maximum. The FSA9480 automatically senses an over-current event,

clamps the current, and reports to the baseband by asserting OCP\_EN in the Interrupt 1 Register. OCP mode is only implemented when V<sub>BUS</sub> is provided by the attached accessory. In PPD Mode (*see below*), the FSA9480 does not limit current supplied by the phone.

## V<sub>BUS</sub> Detect and FET Blocks

This block monitors the status of the V<sub>BUS</sub> pin. A valid V<sub>BUS</sub> level is defined as V<sub>BUS</sub> greater than 4.4V and less than 5.5V. When V<sub>BUS</sub> is determined to be valid, the internal NMOS charging FET is enabled, allowing battery charging whenever a valid V<sub>BUS</sub> is present. The charging FET is designed to limit inrush current to 100mA during enable to allow the voltage levels to stabilize during initial connection. This current limiting is automatic and designed per the requirements outlined in the *USB Battery Charging Specification*.

## I<sup>2</sup>C™ and Digital Core Block

This block includes a full I<sup>2</sup>C slave controller. The I<sup>2</sup>C slave fully complies with the I<sup>2</sup>C specification version 2.1 requirements. This block also includes the FSA9480 chip master controller. The chip controller monitors commands sent to the FSA9480 via I<sup>2</sup>C from the baseband and takes action. The FSA9480 digital core takes inputs from the various functional blocks within the FSA9480 and the I<sup>2</sup>C commands received from the phone baseband and relays relevant status updates to the phone.

## ID Detector with Analog Digital Converter (ADC) Block

This block monitors the ID pin for accessory attach and detach. After determining which accessory has been attached, the detector block reports this back to the digital core, which sends an interrupt to the baseband. Upon detecting changes in the ID pin voltage, the ADC also writes the ADC value bits in the ADC Register. The baseband processor can then read the I<sup>2</sup>C registers and determine the appropriate action. The programmable wait time does not begin until after the baseband acknowledges the interrupt read. Figure 2 outlines the high-level accessory detection flow sequence for Samsung-specific accessories.

## Accessory Detection Flow

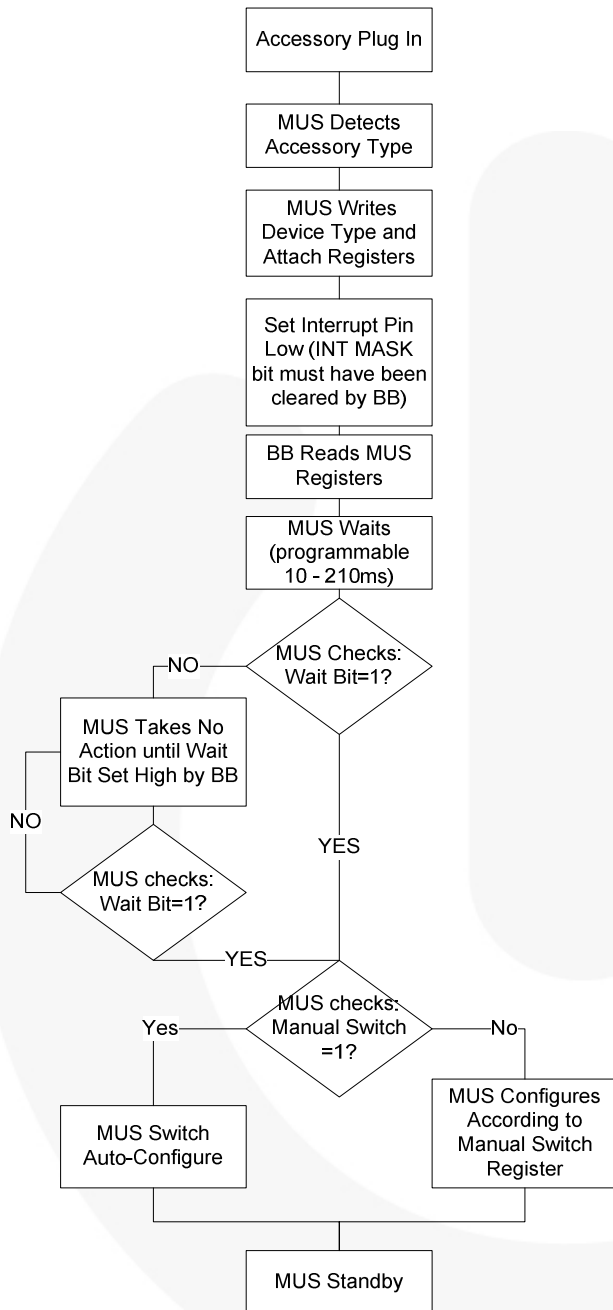

**Figure 2. Accessory Detection Flow Chart (Except USB)**

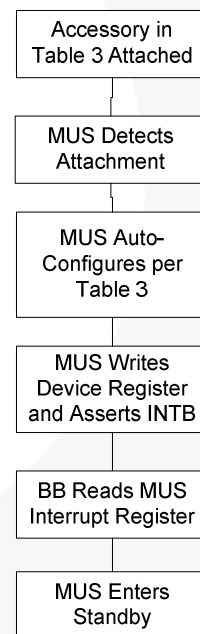

**Figure 3. USB Detection Flow Chart**

**Note:**

3. Figure 2 applies to all accessories except USB; see Figure 3 for the USB accessory detection flow.

Table 2. ADC Selection Table

Bit Number					Equivalent $R_{ID}$ (K $\Omega$ )	Description
4	3	2	1	0		
0	0	0	0	0	GND	USB OTG Mode
0	0	0	0	1	2.000	Audio Send_End Button
0	0	0	1	0	2.604	Audio Remote S1 Button
0	0	0	1	1	3.208	Audio Remote S2 Button
0	0	1	0	0	4.014	Audio Remote S3 Button
0	0	1	0	1	4.820	Audio Remote S4 Button
0	0	1	1	0	6.030	Audio Remote S5 Button
0	0	1	1	1	8.030	Audio Remote S6 Button
0	1	0	0	0	10.030	Audio Remote S7 Button
0	1	0	0	1	12.030	Audio Remote S8 Button
0	1	0	1	0	14.460	Audio Remote S9 Button
0	1	0	1	1	17.260	Audio Remote S10 Button
0	1	1	0	0	20.500	Audio Remote S11 Button
0	1	1	0	1	24.070	Audio Remote S12 Button
0	1	1	1	0	28.700	Reserved Accessory #1
0	1	1	1	1	34.000	Reserved Accessory #2
1	0	0	0	0	40.200	Reserved Accessory #3
1	0	0	0	1	49.900	Reserved Accessory #4
1	0	0	1	0	64.900	Reserved Accessory #5
1	0	0	1	1	80.070	Audio Device Type 2
1	0	1	0	0	102.000	Phone Powered Device
1	0	1	0	1	121.000	TTY Converter
1	0	1	1	0	150.000	UART Cable
1	0	1	1	1	200.000	CEA-936-A Type-1 Charger <sup>(4)</sup>
1	1	0	0	0	255.000	Factory Mode Boot OFF-USB
1	1	0	0	1	301.000	Factory Mode Boot ON-USB
1	1	0	1	0	365.000	Audio/Video Cable
1	1	0	1	1	442.000	CEA-936-A Type-2 Charger <sup>(4)</sup>
1	1	1	0	0	523.000	Factory Mode Boot OFF-UART
1	1	1	0	1	619.000	Factory Mode Boot ON-UART
1	1	1	1	0	1000.070	Audio Device Type 1 with Remote <sup>(4)</sup>
					1002.000	Audio Device Type 1 / Only Send-End <sup>(5)</sup>
1	1	1	1	1	Open	USB Mode, Dedicated Charger or Accessory Detach

**Notes:**

- Chargers must provide a valid  $V_{BUS}$  for the FSA9480 to report them to the phone baseband.
- Audio devices with remote and audio device / only send end are reported as audio in the Device Type 1 Register. The FSA9480 auto-configures in Audio Mode, as described in Table 3.

### Switch MUX Block

The switch MUX block contains an I<sup>2</sup>C controlled DP4T multiplexer with dedicated paths for high-speed USB, audio R/L, TV R/L, and UART signaling. A summary of

the switch auto configuration connections for the various states is shown in Table 3.

**Table 3. Accessory Auto Configuration Table**

Configuration Type	V <sub>BUS</sub>	DP	DM	ID	BOOT	JIG	CHG_DET (I <sub>SET</sub> )	
Audio Type 1	MIC	Audio_R	Audio_L	Key Press Monitor	LOW	Hi-Z	Hi-Z	
Audio Type 2	Chg FET Closed	RxD	TxD	(7)	LOW	Hi-Z	Hi-Z	
TTY	MIC	Audio_R		(7)	LOW	Hi-Z	Hi-Z	
UART	(6)	RxD	TxD	(7)	LOW	Hi-Z	Hi-Z	
USB	Chg FET Closed	DP_Host	DM_Host	IDBP	LOW	Hi-Z	Hi-Z	
USB Charger	Chg FET Closed	DP_Host	DM_Host	IDBP	LOW	Hi-Z	Low	
A/V Cable	(6)	V_Audio_R	V_Audio_L	Video	LOW	Hi-Z	Hi-Z <sup>(8)</sup>	
Dedicated Charger, Car Kit Type I & II Chargers	Chg FET Closed	Open	Open	NA	LOW	Hi-Z	Low	
Phone Powered Device (PPD)	Chg FET Closed	Audio_R	Audio_L	(7)	LOW	Hi-Z	Hi-Z	
Factory Mode Jig: UART	Boot_On	Chg FET Open	RxD	TxD	(7)	HIGH	LOW	Hi-Z
	Boot_Off	Chg FET Open	RxD	TxD	(7)	LOW	LOW	Hi-Z
Factory Mode Jig: USB	Boot_On	Chg FET closed	DP_Host	DM_Host	(7)	HIGH	LOW	Hi-Z
	Boot_Off	Chg FET closed	DP_Host	DM_Host	(7)	LOW	LOW	Hi-Z

**Notes:**

6. If V<sub>BUS</sub> is valid, the charger FET is closed; otherwise, the charger FET is open.
7. ID is monitored by ADC for change of state.
8. Unless V<sub>BUS</sub> is valid, in which case, a charger adapter has been added and CHG\_DET is enabled.

## Mode Descriptions

### Initialization

On initial power up, all register bits are initialized to their default condition, as defined in the I<sup>2</sup>C register map. During initialization, all switch paths are open. Immediately after initializing, all registers transition to Standby/IDLE Mode.

### V<sub>DDIO</sub> Reset Mode

While in active mode, the FSA9480 is reset by the falling edge of the V<sub>DDIO</sub> signal pin as the V<sub>DDIO</sub> level transitions from HIGH to LOW. In this case, the FSA9480 automatically resets to its initialization state. All register bits are initialized to their default condition, as defined in the I<sup>2</sup>C register map. Immediately following V<sub>DDIO</sub> reset all switch paths are open and the FSA9480 transitions to Standby/IDLE Mode. The FSA9480 enters Standby/Idle Mode after the initial reset, while the V<sub>DDIO</sub> pin remains LOW. Immediately after the V<sub>DDIO</sub> level returns to a High and the Interrupt Mask is cleared the FSA9480 reports any activity detected while in Standby/Idle Mode.

### I<sup>2</sup>C Reset Mode

The FSA9480 can also be reset by driving both the SDA and SCL signal lines LOW for 30ms. In this case, the FSA9480 automatically resets all registers to default condition, as defined in the I<sup>2</sup>C register map. Immediately following I<sup>2</sup>C reset, all switch paths are open and FSA9480 transitions to Standby/IDLE mode. See Figure 5 for detailed timing for I<sup>2</sup>C Reset Mode.

### Standby / IDLE

In this state, no accessory is attached. This state is connected to all other states. During this state, the device is in a power-down mode with a minimal set of functions running. The ID detector continuously monitors the ID pin for accessory attach. Upon accessory attach, the FSA9480 transitions to the appropriate mode based on the accessory.

### Charger Mode

When any of the possible charger types are attached, the FSA9480 closes the FET switch and CHG\_DET (I<sub>SET</sub>) is asserted LOW. When CHG\_DET is asserted LOW this signals the phones charger IC to enable high-current mode. When CHG\_DET is Hi-Z, the charger IC defaults to low-current charge mode.

### USB 2.0 and USB OTG Modes

When USB2.0 cable is attached, the FSA9480 configures the switch MUX block according to Table 3. The charger FET is closed.

### Dead Battery / No Battery Mode

When no battery or a dead battery is present, the FSA9480 disables the following pins to Hi-Z: INTB, I<sup>2</sup>C\_SDA, I<sup>2</sup>C\_SCL, Jig, Boot, R<sub>XD</sub>, T<sub>XD</sub>, and CHG\_DET.

### CEA-936-A Car Kit

Upon initial detection of a CEA-936-A car kit accessory, the FSA9480 detects and reports a car kit accessory attachment. The FSA9480 then initiates the car kit signaling protocol, as described in the CEA-936-A specification. Accordingly, the FSA9480 initializes in UART mode, as described section 7.2.2 of the CEA-936-A specification. The FSA9480 implements the four-wire protocol required for state transitions within the CEA-936-A specification. The baseband processor directs the FSA9480, using the mode bits in the Car Kit Register, to signal the FSA9480 to change modes within the car kit protocol. The phone generates the USB, UART, and audio signals and the FSA9480 multiplexes the appropriate signal out to the attached car kit device. The FSA9480 performs all handshaking necessary with the attached car kit accessory and automatically configures the switch MUX based on the mode setting called for by the baseband processor. Car Kit Audio Mode requires a 1.2V bias applied to the audio signal. The FSA9480 contains a special audio path that provides a 1.2V bias to the Audio\_R and Audio\_L channels when in Car Kit Audio Mode. To achieve the proper bias, the FSA9480 incorporates a separate car kit audio path, containing two unity gain amplifiers. The FSA9480 also uses these audio amplifiers to implement the Car Kit Data During Audio (DDA) Mode. While in DDA mode, the phone must limit the audio signal being driven through the FSA9480 to amplitude no greater than 1V, peak to peak.

### Phone Powered Device Mode (PPD)

In Phone Power Device (PPD) Mode, the cell phone provides power to the attached accessory through the charger FET. In this mode, the charger FET is not closed until after the wait time has expired; at which time, the phone should have already biased its output voltage level on the V<sub>BUS</sub> pin. The phone should never source more than 10mA through the FSA9480 charger FET while in PPD mode. When in PPD mode, the charger FET provides a current path out of the phone to the PPD. There is no inrush current limiting or OCP protection provided by the charger FET when the FSA9480 is in PPD Mode.

### Audio Modes

When any of the compatible headsets are attached, the FSA9480 configures as described in Table 3. The FSA9480 is compatible with Samsung headphones that include a remote-control feature. When in Audio Mode, the FSA9480 continuously monitors for remote-control button presses and reports any presses back to the baseband. Figure 15 illustrates the headset with remote basic circuit; Table 4 provides resistor values.

**Audio Device Type-1** accessories are passive devices with only one switch configuration per device. They may or may not include a remote controller.

**Audio Device Type-2** devices include a built-in UART controller and the FSA9480 auto configures with UART switch paths connected, as described in Table 3. These devices include a remote controller. After initial configuration in UART Mode, the baseband may change the FSA9480 switch mode configuration by writing any of the following bit patterns in the Car Kit Status Register mode bits: 000, 001, 100, 101. While an audio type-2 accessory is attached, it is possible for the baseband to signal changes in switch configuration from any mode to any mode until device detach is detected. While in DDA Mono (100) mode, the FSA9480 DDA circuitry is activated, allowing data to be sent and received during audio transmission between the resident UART transceivers in the phone and the audio type-2 device. The FSA9480 DDA audio scheme follows that of the CEA-936-A specification as implemented in the car kit mode of the FSA9480. Other than implementing the DDA transmission and reception scheme in CEA-936-A, the FSA9480 does not implement any car kit protocols or state machines while in Audio Device Type-2 Mode. In DDA Mode, the phone must limit the audio signal driven through the FSA9480 to amplitude no greater than 1V, peak to peak.

### Factory Modes

Factory Modes are initiated with the attachment of a Samsung proprietary JIG Box and are used for phone assembly and testing. The Factory Mode attach procedure is slightly different from the standard accessory attach flow. The primary difference is that the

FSA9480 automatically configures the switch paths as soon as a Factory Mode accessory is attached and  $V_{DDIO}$  is present. This is unique in that the FSA9480 does not wait for an I<sup>2</sup>C read acknowledge from the baseband and does not employ the switch wait timer. A second difference is that, in this mode, the JIG pin is driven LOW even if the VDDIO pin is LOW. Figure 4 provides the attach flow for the JIG Box accessory.

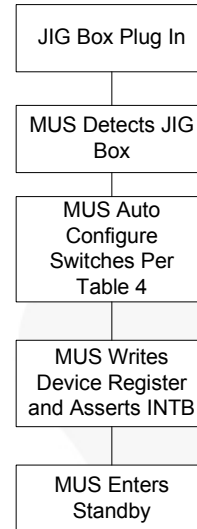

Figure 4. JIG Box Detection Flow



# I<sup>2</sup>C Manual Reset Timing

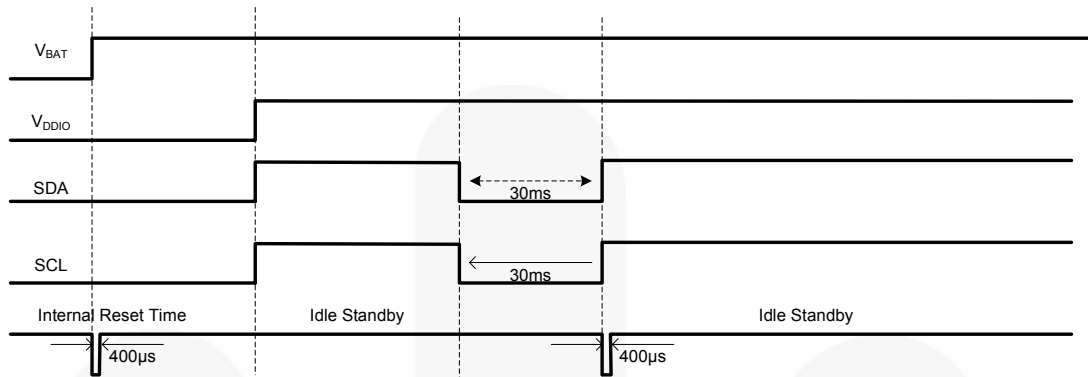

Figure 5. I<sup>2</sup>C Reset Mode Timing



## Interrupt Operation Description

The FSA9480 follows the Interrupt guidelines as described in the Samsung Interrupt Definition and Default Path specification Rev 0.1 released July 15 2008. The baseband processor recognizes interrupt signals by observing the falling edge of the INTB signal in a high-to-low transition. During the phone power-up sequence, V<sub>DDIO</sub> reset or I<sup>2</sup>C reset the INTB pin is masked on initialization and defaults LOW. After the INTB mask is cleared by the baseband processor, the INTB pin is HIGH in preparation of a future interrupt. If the interrupt mask bit in the I<sup>2</sup>C Control Register is

written HIGH when the system is already powered up, the INTB remains HIGH until the INTB mask is cleared. If an interruptible event occurs while the INTB pin is masked, the FSA9480 changes the appropriate register value and waits until the INTB mask bit is cleared, plus the switch wait time before signaling an interrupt to the baseband. Figure 6 illustrates the interrupt timing for the FSA9480 during initial power up. Figure 7 shows the INTB behavior during a V<sub>DDIO</sub> reset. Figure 8 illustrates the INTB timing when the INT Mask bit is written by the baseband using I<sup>2</sup>C commands.

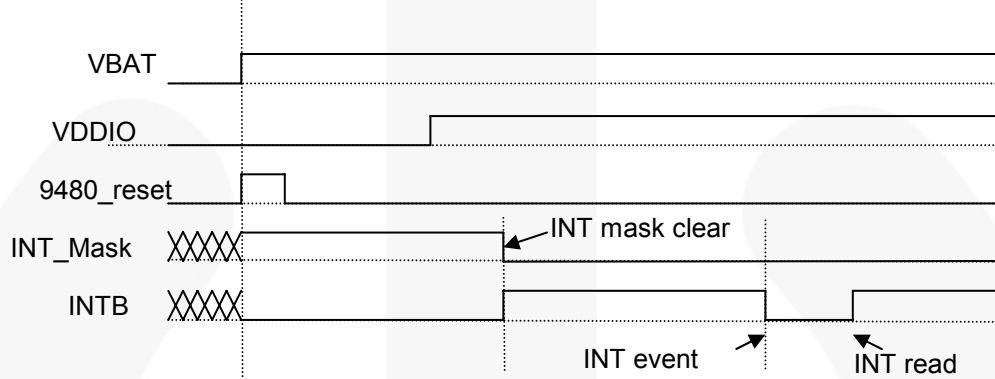

**Figure 6. Power-Up Interrupt Timing Diagram**

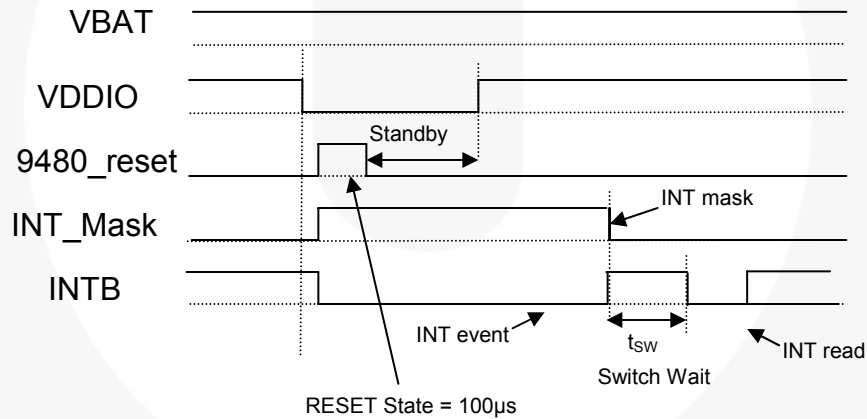

**Figure 7. VDDIO Reset Interrupt Timing Diagram**

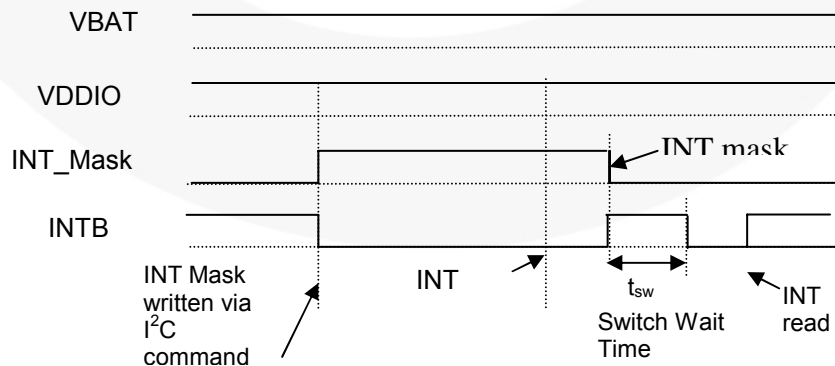

**Figure 8. INT Mask via I<sup>2</sup>C Command Interrupt Timing Diagram**

Device Attach Timing Diagrams

USB Cable Attach Timing

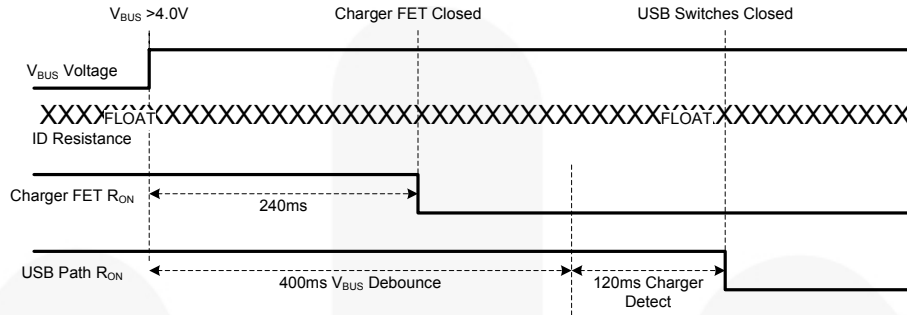

Figure 9. USB Cable Attach Timing Diagram

ID Based Accessories No V<sub>BUS</sub>

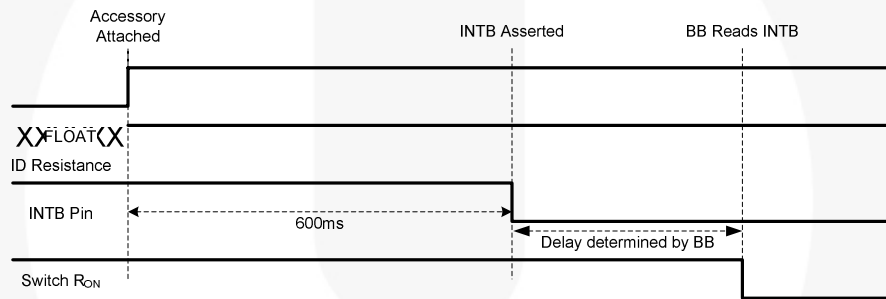

Figure 10. ID Based Accessories Attach Timing

JIG Box Attach Timing (V<sub>BUS</sub> Present)

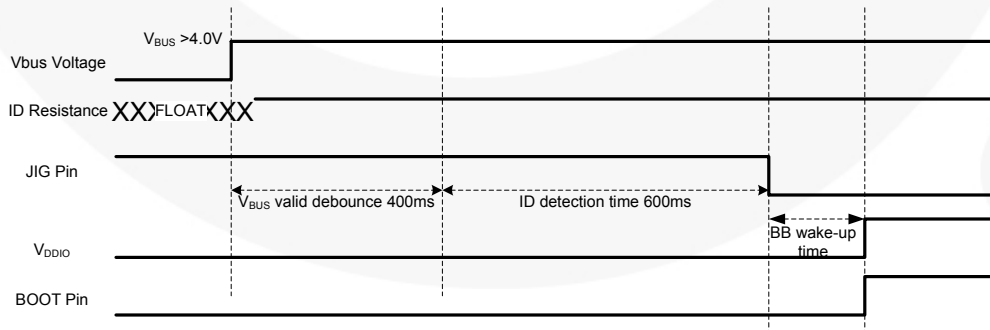

Figure 11. JIG Box Attach Timing (V<sub>BUS</sub> Present)

Device Attach Timing Diagrams (Continued)

### JIG Box Attach Timing (No $V_{BUS}$ )

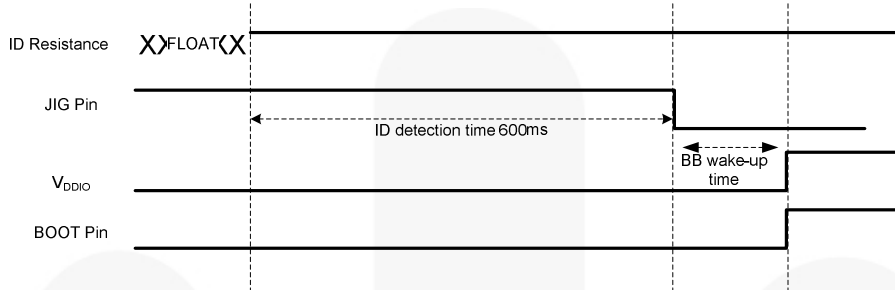

Figure 12. JIG Box Attach Timing (No  $V_{BUS}$ )

### Dedicated Charger (TA) Attach Timing

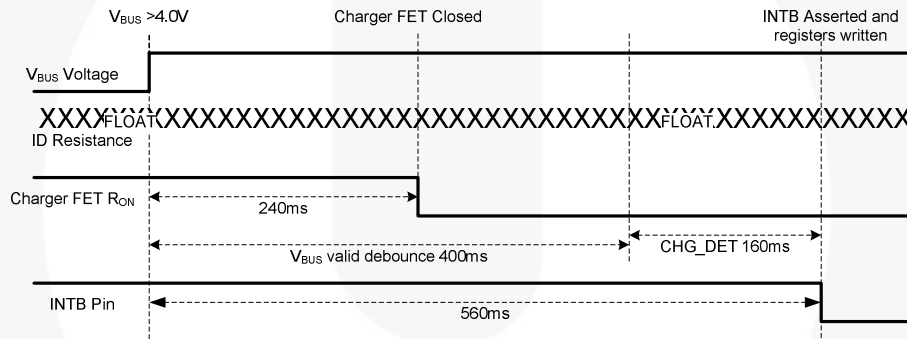

Figure 13. Dedicated Charger (TA) Attach Timing

### USB Charging Host Port Attach Timing

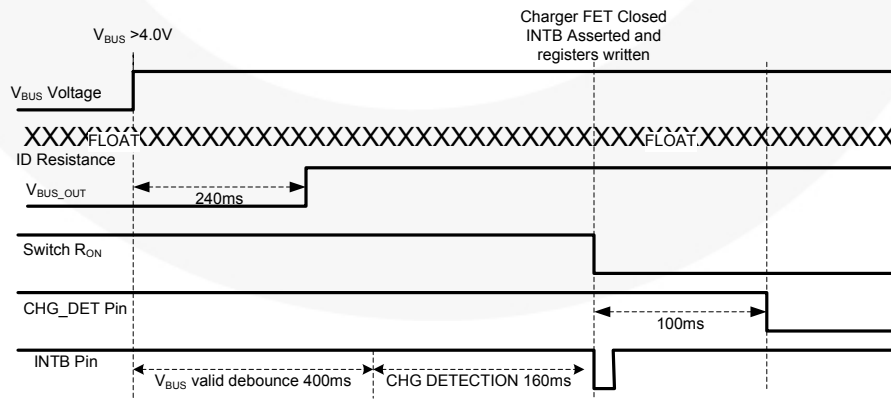

Figure 14. USB Charging Host Port Attach Timing

## Audio Type 1 and 2 Remote Control Configuration

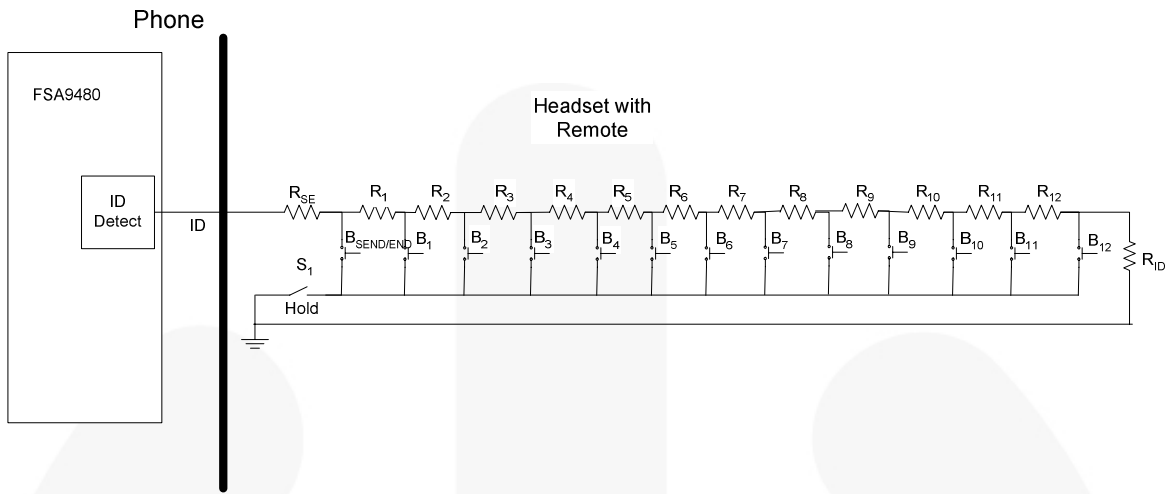

Figure 15. Stereo Headset with Remote Configuration

Table 4. Remote Control Resistor Table (1% Resistor Values)

Switch and Resistor Number	Resistor Value	Resistor Number	Resistor Value
RSE	2K $\Omega$	B7, R7	2K $\Omega$
B1, R1	0.604K $\Omega$	B8, R8	2K $\Omega$
B2, R2	0.604K $\Omega$	B9, R9	2.43K $\Omega$
B3, R3	0.806K $\Omega$	B10, R10	2.8K $\Omega$
B4, R4	0.806K $\Omega$	B11, R11	3.24K $\Omega$
B5, R5	1.21K $\Omega$	B12, R12	3.57K $\Omega$
B6, R6	2K $\Omega$	RID	976K $\Omega$ (Audio Type 1)
			56K $\Omega$ (Audio Type 2)

### Key Press Timing Diagrams

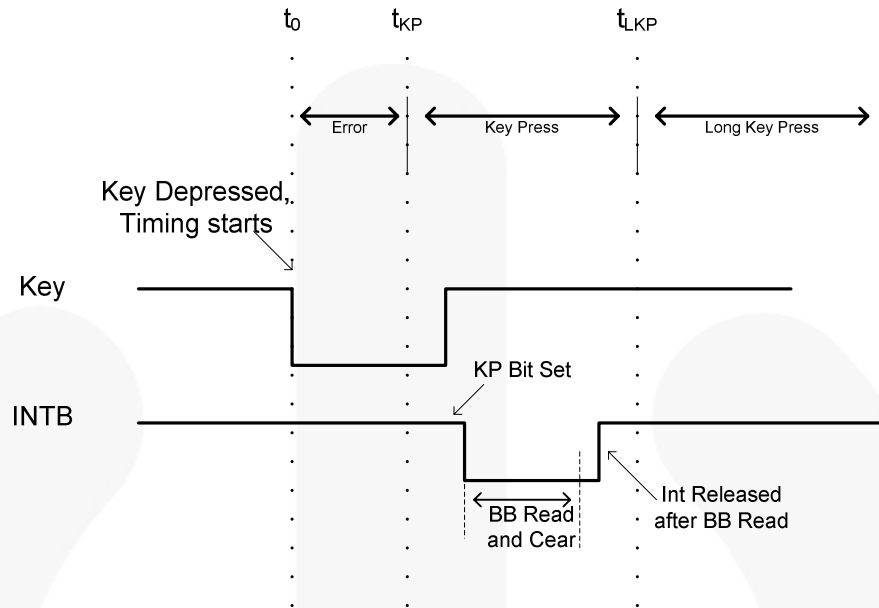

Figure 16. Regular Key Press Timing Diagram

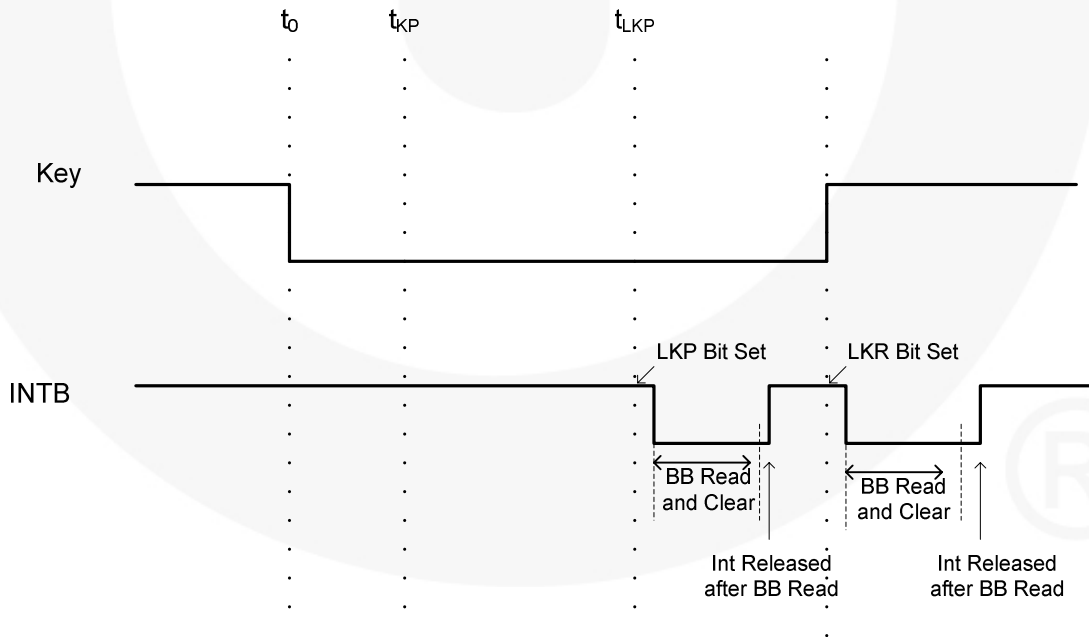
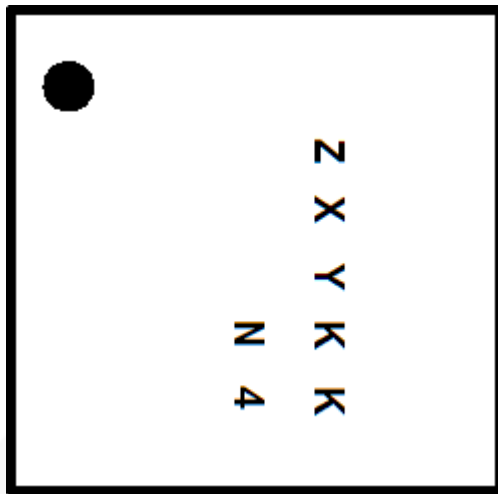

Figure 17. Long Key Press Timing Diagram

### Marking Information



- Z** = Assembly Plant Code
- X** = Year
- Y** = Work Week
- KK** = Lot Trace Code
- N4** = Product Identifier

Figure 18. Top Mark with Pin A1 Orientation

### Pin Configuration

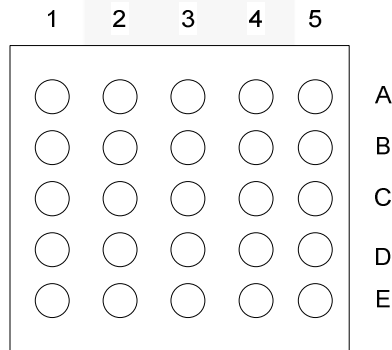

Figure 19. 25-Pin, WLCSP Pin Assignments (Top Through View)

### Pin Map

	Column 1	Column 2	Column 3	Column 4	Column 5
Row A	INTB	VDDIO	CHG_DET	VBUS_OUT	VBUS_IN
Row B	DP_Host	I <sup>2</sup> C_SDA	Audio_L	MIC	DM_CON
Row C	DM_Host	I <sup>2</sup> C_SCL	V_Audio_L	Audio_R	DP_CON
Row D	VBAT	ID_Bypass	V_Audio_R	Video	ID_CON
Row E	RxD	TxD	BOOT	JIG	GND

## Pin Descriptions

Name	Pin #	Type	Default State	Description
<b>USB Interface</b>				
DP_Host	B1	Signal Path	Open	D+ signal, dedicated USB port to be connected to the resident USB transceiver on the phone
DM_Host	C1	Signal Path	Open	D- signal, dedicated USB port to be connected to the resident USB transceiver on the phone
ID_Bypass	D2	Signal Path	Open	USB ID pin bypass allows the FSA9480 to pass the ID signal pin through to the resident phone USB controller when a USB accessory is attached
<b>Audio Interface</b>				
Audio_L	B3	Signal Path	Open	Left audio channel from phone audio-out codec
Audio_R	C4	Signal Path	Open	Right audio channel from phone audio-out codec
MIC	B4	Signal Path	Open	Connected to the phone audio codec MIC input pin
<b>Video Interface</b>				
Video	D4	Signal Path	Open	Input signal driven by the phone DMB video-out signal
V_Audio_L	C3	Signal Path	Open	Left audio channel from TV audio out
V_Audio_R	D3	Signal Path	Open	Right audio channel from TV audio out
<b>UART Interface</b>				
TxD	E2	Signal Path	Open	Tx connection from resident UART transceiver on the phone
RxD	E1	Signal Path	Open	Rx connection from resident UART transceiver on the phone
<b>Factory Interface</b>				
Jig	E4	Open-Drain Output	Hi-Z	Output control signal driven by the FSA9480; used by the processor for Samsung factory test modes
Boot	E3	Push-Pull Output	LOW	Output control signal driven by the FSA9480, used by the processor for Samsung factory test modes
<b>Power Interface</b>				
V <sub>BAT</sub>	D1	Power	N/A	Input voltage supply pin to be connected to the phone battery output
V <sub>BUS_OUT</sub>	A4	Power	N/A	Output voltage supply pin to be connected to the source voltage pin on the charger IC
V <sub>DDIO</sub>	A2	Power	N/A	Input baseband interface I/O supply pin
CHG_DET (I <sub>SET</sub> )	A3	Open-Drain Output	Hi-Z	Open-drain I/O pin, active LOW, used to signal charger IC that a charger has been attached

Continued on the following page...



**Pin Descriptions** (Continued)

Name	Pin #	Type	Default State	Description
<b>Connector Interface</b>				
V <sub>BUS_IN</sub>	A5	Power	N/A	Input voltage supply pin; connect to the V <sub>BUS</sub> pin of the USB connector
GND	E5	Power	N/A	Ground
ID_CON	D5	Signal Path	Open	Connected to the USB connector ID pin; depending on the FSA9480 state, this pin can share ID or video signals
DP_CON	C5	Signal Path	Open	Connected to the USB connector D+ pin; depending on the FSA9480 signaling mode, this pin can share D+, S_R, V_R, Rxd, or MIC signals
DM_CON	B5	Signal Path	Open	Connected to the USB connector D- pin; depending on the FSA9480 signaling mode, this pin can share D-, S_L, Txd, or V_L signals
<b>I<sup>2</sup>C Interface</b>				
I <sup>2</sup> C_SCL	C2	Input	N/A	I <sup>2</sup> C serial clock signal to be connected to the phone based I <sup>2</sup> C master
I <sup>2</sup> C_SDA	B2	Open-Drain I/O	Hi-Z	Open-drain I/O pin; I <sup>2</sup> C serial data signal to be connected to the phone based I <sup>2</sup> C master
INTB	A1	Push-Pull Output	Low	Interrupt signal to prompt the phone baseband to read the I <sup>2</sup> C register bits, indicates a change in ID pin status or accessory attach status

## Absolute Maximum Ratings

Stresses exceeding the absolute maximum ratings may damage the device. The device may not function or be operable above the recommended operating conditions and stressing the parts to these levels is not recommended. In addition, extended exposure to stresses above the recommended operating conditions may affect device reliability. The absolute maximum ratings are stress ratings only.

Symbol	Parameter		Min.	Max.	Unit
$V_{BAT}/V_{DDIO}$	Supply Voltage from Battery / Baseband		-0.5	6.0	V
$V_{BUS}$	Supply Voltage from Mini-USB Connector		-0.5	28.0	V
$V_{SW}$	Switch I/O Voltage	USB or Car Kit Path Active	-1.0	$V_{BUS}+0.5$	V
		Stereo/Mono Audio Path Active	-1.5	$V_{BAT}+0.5$	
		All Other Channels	-0.5	$V_{BAT}+0.5$	
$I_{IK}$	Input Clamp Diode Current		-50		mA
Chg_Det	Charger Detect Sets Current Sink Capability of the Charger IC			30	mA
$I_{SW}$	Switch I/O Current (Continuous)	USB		50	mA
		Audio		60	
		All Other Channels		50	
$I_{SWPEAK}$	Peak Switch Current (Pulsed at 1ms Duration, <10% Duty Cycle)	USB		150	mA
		Audio		150	mA
		Charger FET		1.2	A
		All Other Channels		150	mA
$T_{STG}$	Storage Temperature Range		-65	+150	°C
$T_J$	Maximum Junction Temperature			+150	°C
$T_L$	Lead Temperature (Soldering, 10 Seconds)			+260	°C
ESD	IEC 61000-4-2 System Electrostatic Discharge	USB Connector Pins (D+, D-, $V_{BUS}$ , ID)	Air Gap	15	kV
			Contact	8	
	JEDEC JESD22-A114, Human Body Model		All Pins	4	

## Recommended Operating Conditions

The Recommended Operating Conditions table defines the conditions for actual device operation. Recommended operating conditions are specified to ensure optimal performance to the datasheet specifications. Fairchild does not recommend exceeding them or designing to Absolute Maximum Ratings.

Symbol	Parameter		Min.	Max.	Units
$V_{BAT}$	Battery Supply Voltage		3.0	4.4	V
$V_{BAT\_TH}$	Battery Supply Voltage Threshold			3.0	V
$V_{BUS}$	Supply Voltage		4.00	5.25	V
$V_{DDIO}$	Baseband-supplied Reference Voltage		1.8	3.6	V
$V_{SW}$	Switch I/O Voltage	USB Path Active	0	3.6	V
		Audio Path Active	-0.8	0.8	V
		All Other Pins	0	5.0	V
$ID_{Cap}$	Maximum Capacitive Load on ID pin for Reliable Accessory Detection			1.5	nF
$T_A$	Operating Temperature		-40	+85	°C

## Switch Path DC Electrical Characteristics

All typical values are at 25°C unless otherwise specified.

Symbol	Parameter	V <sub>BAT</sub> (V)	Conditions	T <sub>A</sub> = -40 to +85°C			Unit
				Min.	Typ.	Max.	
<b>UART Interface Pins</b>							
V <sub>OHRXD</sub>	R <sub>XD</sub> Output High Voltage	3.0 to 4.4	I <sub>OH</sub> =2mA	0.7 • V <sub>DDIO</sub>			V
V <sub>OLRXD</sub>	R <sub>XD</sub> Output Low Voltage	3.0 to 4.4	I <sub>OL</sub> =10mA			0.4	V
V <sub>IHDPCon</sub>	UART Input (DP_Con) High Voltage	3.0 to 4.4		0.7 • V <sub>DDIO</sub>			V
V <sub>ILDPCon</sub>	UART Path (DP_Con) Input Low Voltage	3.0 to 4.4				0.4	V
V <sub>OHDMCon</sub>	UART Output (DM_Con) High Voltage	3.0 to 4.4	I <sub>OH</sub> =2mA	0.7 • V <sub>BAT</sub>			V
V <sub>OLDMCon</sub>	UART Output (DM_Con) Low Voltage	3.0 to 4.4	I <sub>OL</sub> =10mA			0.4	V
V <sub>IHTXD</sub>	T <sub>XD</sub> Input High Voltage	3.0 to 4.4		0.7 • V <sub>DDIO</sub>			V
V <sub>ILTXD</sub>	T <sub>XD</sub> Input Low Voltage	3.0 to 4.4				0.4	V
<b>Host Interface Pins (JIG, BOOT, INTB, CHG-DET)</b>							
V <sub>OH</sub>	Output High Voltage <sup>(9)</sup>	3.0 to 4.4	I <sub>OH</sub> =2mA	0.7 • V <sub>DDIO</sub>			V
V <sub>OL</sub>	Output Low Voltage	3.0 to 4.4	I <sub>OL</sub> =10mA			0.4	V
<b>Switch Off Characteristics</b>							
I <sub>OFF</sub>	Power Off Leakage Current	0	All Data Ports Except Video, ID Bypass and MIC V <sub>SW</sub> =0V to 4.4V			18	μA
I <sub>NO(OFF)</sub>	Off-Leakage Current	3.0 to 4.4	I/O pins=0.3V, V <sub>BAT</sub> , or Floating	-100	1	100	nA
<b>USB Switch On Path</b>							
USB Analog Signal Range		3.0 to 4.4		0		3.6	V
R <sub>ONUSB</sub>	HS Switch On Resistance <sup>(10,13)</sup>	3.0 to 4.4	V <sub>D+/D-</sub> =0V, 0.4V, I <sub>ON</sub> =8mA		6	8	Ω
<b>Charging FET On Path</b>							
V <sub>OVP</sub>	OVP Threshold Voltage <sup>(13)</sup>	3.8		6.2	6.6	7.0	V
R <sub>ONFET</sub>	Charging FET On Resistance <sup>(10)</sup>		V <sub>BUS</sub> =4.2V to 5.0V, I <sub>ON</sub> =1A		100		mΩ
I <sub>OCP</sub>	OCP Threshold Current <sup>(13)</sup>			1.1	1.5	1.6	A
I <sub>RUSH</sub>	Charging FET Inrush Current Limiting <sup>(13)</sup>		C <sub>L</sub> =4.7μF Typical, C <sub>L</sub> =10μF Maximum, Duration = 100ms after Initial Attach			100	mA
<b>Audio R/L Switch On Paths</b>							
DC Audio Analog Signal Range		3.0 to 4.4		0		3	V
AC Audio Analog Signal Range		3.0 to 4.4		-1.5		3.0	V
R <sub>ON</sub>	Audio Switch On Resistance <sup>(10,13)</sup>	3.8	V <sub>L/R</sub> =-0.8V, 0.8V, I <sub>ON</sub> =30mA, f=0-470kHz		2.0	3.0	Ω
R <sub>FLAT</sub>	Audio R <sub>ON</sub> Flatness <sup>(11)</sup>	3.8			0.1		Ω

Symbol	Parameter	V <sub>BAT</sub> (V)	Conditions	T <sub>A</sub> = -40 to +85°C			Unit
				Min.	Typ.	Max.	
<b>Video Audio R/L Switch On Paths</b>							
DC Audio Analog Signal Range <sup>(14)</sup>		3.0 to 4.4		0		3	V
AC Audio Analog Signal Range <sup>(14)</sup>		3.0 to 4.4		-1.5		3.0	V
R <sub>ON</sub>	Audio Switch On Resistance <sup>(10,13)</sup>	3.0 to 4.4	V <sub>L/R</sub> =0V, 1.6V, I <sub>ON</sub> =30mA, f=0-470kHz		2.8	5.0	Ω
R <sub>FLAT</sub>	Audio R <sub>ON</sub> Flatness <sup>(11,13)</sup>	3.0 to 4.4			0.2	0.4	Ω
<b>MIC Switch On Path</b>							
Analog Signal Range <sup>(12)</sup>		3.0 to 4.4		0		4.4	V
R <sub>ON</sub>	Switch On Resistance <sup>(10)</sup>	3.0 to 4.4	V <sub>SW</sub> =1.4 to 1.8V, I <sub>ON</sub> =30mA	25	40	52	Ω
<b>IDBP and Video Switch On Paths</b>							
Analog Signal Range		3.0 to 4.4		0		4.4	V
R <sub>ON</sub>	Switch On Resistance <sup>(10,13)</sup>	3.0 to 4.4	V <sub>SW</sub> =0V, 4.4V, I <sub>ON</sub> =30mA	10	15	20	Ω
<b>Total Switch Current Consumption</b>							
I <sub>CCSLNA</sub>	Battery Supply Sleep Mode Current No Accessory Attached	3.8	Static Current During Sleep Mode		9	15	μA
I <sub>CCSLWA</sub>	Battery Supply Sleep Mode Current with Accessory Attached <sup>(13)</sup>	3.8	Static Current During Sleep Mode		30	40	μA
I <sub>CCWK</sub>	Battery Supply Active Mode Current <sup>(13)</sup>	3.8	Average Pulse Current (~100μs Pulse)		2.5	3	mA

**Notes:**

9. Does not apply to CHG\_DET or JIG pins.
10. On resistance is determined by the voltage drop between the A and B pins at the indicated current through the switch.
11. Flatness is defined as the difference between the maximum and minimum values of on resistance over the specified range of conditions.
12. The MIC bias applied by the phone should not exceed 3.5V.
13. Guaranteed by characterization data.
14. Negative swing audio is not recommended when the switch is open.

## Capacitance

Symbol	Parameter	V <sub>BAT</sub> (V)	Conditions	T <sub>A</sub> = -40 to +85°C			Unit
				Min.	Typ.	Max.	
C <sub>INOFF</sub>	Host Interface Pins Off Capacitance	3.8	V <sub>BIAS</sub> =0V		10		pF
C <sub>ON(D+, D-)</sub>	D+, D- On Capacitance (USB Mode)	3.8	V <sub>BIAS</sub> =0.2V, f=1MHz		8		pF

## I<sup>2</sup>C™ Controller DC Characteristics

Symbol	Parameter	Fast Mode (400kHz)			
		Min.	Max.	Unit	
V <sub>IL</sub>	Low-Level Input Voltage	-0.5	0.3V <sub>DDIO</sub>	V	
V <sub>IH</sub>	High-Level Input Voltage	0.7V <sub>DDIO</sub>		V	
V <sub>OL1</sub>	Low-Level Output Voltage at 3mA Sink Current (Open-Drain or Open-Collector)	V <sub>DDIO</sub> >2V	0	0.4	V
		V <sub>DDIO</sub> <2V		0.2V <sub>DDIO</sub>	
I <sub>I</sub>	Input Current of Each I/O Pin, Input Voltage 0.26V to 2.34V	-10	10	μA	
C <sub>I</sub>	Capacitance for Each I/O Pin		10	pF	

## Switch Path AC Electrical Characteristics

All typical value are for V<sub>BAT</sub>=3.8V at 25°C unless otherwise specified.

Symbol	Parameter	V <sub>BAT</sub> (V)	Conditions	T <sub>A</sub> = -40 to +85°C			Unit
				Min.	Typ.	Max.	
Xtalk	Non-Adjacent Channel Crosstalk	Audio Mode	f=20kHz, R <sub>T</sub> =32Ω, C <sub>L</sub> =0pF		-50		dB
		USB Mode	f=1MHz, R <sub>T</sub> =50Ω, C <sub>L</sub> =0pF		-60		
O <sub>IRR</sub>	Off Isolation	Audio Mode	f=20kHz, R <sub>T</sub> =32Ω, C <sub>L</sub> =0pF		-100		dB
		USB Mode	f=1 MHz, R <sub>T</sub> =50Ω, C <sub>L</sub> =0pF		-60		
PSRR	Power Supply Rejection Ratio	3.8	Power Supply Noise 300mV <sub>PP</sub> , f=217Hz on MIC, DP_Con, DM_Con		-100		dB
t <sub>SK(P)</sub>	Skew of Opposite Transitions of the Same Output (USB Mode)	3.8	t <sub>r</sub> =t <sub>f</sub> =750ps (10-90%) at 240MHz, C <sub>L</sub> =0pF, R <sub>L</sub> =50Ω		35		ps
t <sub>J</sub>	Total Jitter (USB Mode)	3.8	R <sub>L</sub> =50Ω, C <sub>L</sub> =50pF, t <sub>r</sub> =t <sub>f</sub> =500ps (10-90%) at 480Mbps (PRBS=2 <sup>15</sup> -1)		130		ps

## I<sup>2</sup>C™ AC Electrical Characteristics

Symbol	Parameter	Fast Mode		
		Min.	Max.	Unit
f <sub>SCL</sub>	SCL Clock Frequency	0	400	kHz
t <sub>HD;STA</sub>	Hold Time (Repeated) START Condition	0.6		μs
t <sub>LOW</sub>	Low Period of SCL Clock	1.3		μs
t <sub>HIGH</sub>	High Period of SCL Clock	0.6		μs
t <sub>SU;STA</sub>	Set-up Time for Repeated START Condition	0.6		μs
t <sub>HD;DAT</sub>	Data Hold Time	0	0.9	μs
t <sub>SU;DAT</sub>	Data Set-Up Time	100 <sup>(15)</sup>		ns
t <sub>r</sub>	Rise Time of SDA and SCL Signals <sup>(16)</sup>	20+0.1C <sub>b</sub>	300	ns
t <sub>f</sub>	Fall Time of SDA and SCL Signals <sup>(16)</sup>	20+0.1C <sub>b</sub>	300	ns
t <sub>SU;STO</sub>	Set-up Time for STOP Condition	0.6		μs
t <sub>BUF</sub>	Bus Free Time between a STOP and START Conditions	1.3		μs
t <sub>SP</sub>	Pulse Width of Spikes that Must Be Suppressed by the Input Filter	0	50	ns

**Note:**

- A fast-mode I<sup>2</sup>C-bus device can be used in a Standard-mode I<sup>2</sup>C-bus system, but the requirement t<sub>SU;DAT</sub> ≥ 250ns must be met. This is automatically the case if the device does not stretch the LOW period of the SCL signal. If the device stretches the LOW period of the SCL signal, it must output the next data bit to the SDA line t<sub>r max</sub> + t<sub>SU;DAT</sub>=1000+250=1250ns (according to the standard-mode I<sup>2</sup>C-bus specification) before the SCL line is released.
- C<sub>b</sub> equals the total capacitance of one bus line in pf. If mixed with high-speed mode devices, faster fall times are allowed according to the I<sup>2</sup>C specification.

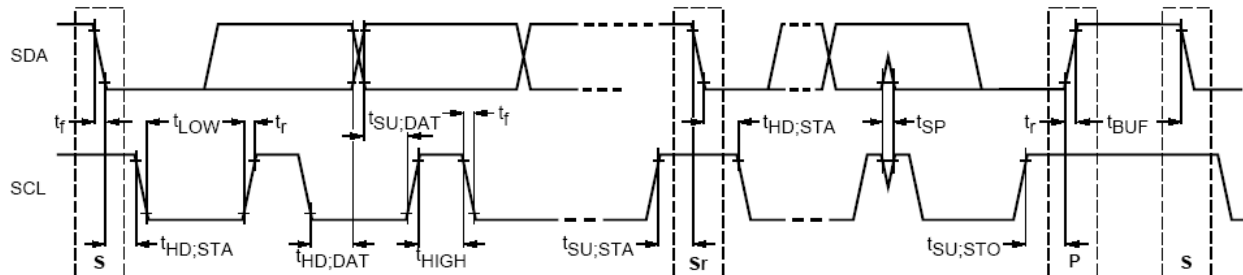

**Figure 20. Definition of Timing for Full-Speed Mode Devices on the I<sup>2</sup>C-bus**

**Table 5. I<sup>2</sup>C™ Slave Address**

Name	Size (Bits)								
Slave Address	8	Bit 7	Bit 6	Bit 5	Bit 4	Bit 3	Bit 2	Bit 1	Bit 0
		0	1	0	0	1	0	1	R/W

**Table 6. I<sup>2</sup>C™ Register Map**

Address	Register	Type	Reset Value	Bit 7	Bit 6	Bit 5	Bit 4	Bit 3	Bit 2	Bit 1	Bit 0
01H	Device ID	R	N/A	Version ID				Vendor ID			
02H	Control	R/W	XXX11111	Reserved	Reserved	Reserved	Switch Open	RAW Data	Manual S/W	Wait	INT Mask
03H	Interrupt 1 <sup>(17)</sup>	R	00000000	OVP_OCP_DIS	OCP_EN	OVP_EN	LKR	LKP	KP	Detach	Attach
04H	Interrupt 2 <sup>(17)</sup>	R	XXX00000	Reserved	Reserved	Reserved	Stuck Key RCV	Stuck Key	ADC Change	Reserved Attach	A/V Charging
05H	Interrupt Mask 1	R/W	00000000	OVP_OCP_DIS	OCP_EN	OVP_EN	LKR	LKP	KP	Detach	Attach
06H	Interrupt Mask 2	R/W	XXX00000	Reserved	Reserved	Reserved	Stuck Key RCV	Stuck Key	ADC Change	Reserved Attach	A/V Charging
07H	ADC	R	XXX11111	Reserved	Reserved	Reserved	ADC Value				
08H	Timing Set 1	R/W	00000100	Key Press				Device Wake Up			
09H	Timing Set 2	R/W	00000000	Switching Wait				Long Key Press			
0AH	Device Type 1	R	00000000	USB OTG	Dedicated CHG	USB Charger	Car kit	UART	USB	Audio Type 2	Audio Type 1
0BH	Device Type 2	R	X0000000	Reserved	A/V	TTY	PPD	Jig UART Off	Jig UART On	Jig USB Off	Jig USB On
0CH	Button 1	R	00000000	7	6	5	4	3	2	1	Send End
0DH	Button 2	R	X0000000	Reserved	Unknown	Error	12	11	10	9	8
0EH	Car Kit Status	R/W <sup>(18)</sup>	X0000100	Reserved	DISC_Req_uest	UART Traffic	Mode			Type	
0FH	Car Kit Int 1	R	00000000	CR_UART	PH_Disc	PH_DDA_Stereo	PH_DDA_Mono	PH_Aud_Stereo	PH_Aud_Mono	PH_UART	PH_Init
10H	Car Kit Int 2	R	XXXXX000	Reserved	Reserved	Reserved	Reserved	Reserved	CR_DDA_Stereo	CR_Stereo	CR_Mono
11H	Car Kit Int Mask 1	R/W	00000000	CR_UART	PH_Disc	PH_DDA_Stereo	PH_DDA_Mono	PH_Aud_Stereo	PH_Aud_Mono	PH_UART	PH_Init
12H	Car Kit Int Mask 2	R/W	XXXXX000	Reserved	Reserved	Reserved	Reserved	Reserved	CR_DDA_Stereo	CR_Stereo	CR_Mono
13H	Manual SW 1	R/W	00000000	D- Switching			D+ Switching			V <sub>BUS</sub> switching	
14H	Manual SW 2	R/W	XXX00000	Reserved	Reserved	Reserved	Reserved	BOOT SW	JIG ON	ID Switching	

**Notes:**

- The following four bit pairs are mutually exclusive; OVP\_EN/OVP\_DIS, Stuck\_Key/Stuck\_Key\_Rcv, LKP/LKR, Detach/Attach. If the FSA9480 writes either bit in these pairs before its counterpart has been read and cleared, the FSA9480 clears the first bit before writing the second bit in the mutually exclusive pair. This ensures only one bit from each pair is ever HIGH.
- Bits 0 and 1 of the Car Kit Status Register 0EH cannot be written.

**Table 7. Device ID**

- Address: 01h
- Type: Read

Bit #	Name	Size (Bits)	Description
7:3	Version ID	5	Rev1.0, Rev 1.1 : 000000 Rev2.0: 00001 Rev2.1: 00010 Rev3.0: 00011 Rev3.1: 00100 Rev3.2: 00101
2:0	Vendor ID	3	000: Fairchild Semiconductor

**Table 8. Control**

- Address: 02h
- Reset Value: xxx11111
- Type: Read/Write

Bit #	Name	Size (Bits)	Description
7:5	Reserved	3	NA
4	Switch Open	1	0: Open all switches 1: Automatic switching by accessory status
3	RAW Data	1	0: Report the status changes on ID to HOST 1: Don't report the status changes on ID to HOST
2	Manual S/W	1	0: Manual switching mode (refer to attach flow diagram Figure 2) 1: Automatic switching mode (refer to attach flow diagram Figure 2)
1	Wait	1	0: Keep all switches open until this bit is reset to 1 by the baseband; when reset to 1, immediately configure the switches 1: Wait for the duration of wait time specified in Timing Set Register before configuring switches
0	INT Mask	1	0: Unmask interrupt – interrupt baseband on change of state in either Interrupt Register 1: Mask interrupt – do not interrupt baseband

**Table 9. Interrupt 1**

- Address: 03h
- Reset Value: 00000000
- Type: Read/Clear

Bit #	Name	Size (Bits)	Description
7	OVP_OCP_DIS	1	1: OVP and OCP disabled
6	OCP_EN	1	1: OCP enabled
5	OVP_EN	1	1: OVP enabled
4	LKR	1	1: Long key release
3	LKP	1	1: Long key press
2	KP	1	1: Key press
1	Detach	1	1: Accessory detached
0	Attach	1	1: Accessory attached



**Table 10. Interrupt 2**

- Address: 04h
- Reset Value: xxx00000
- Type: Read/Clear

Bit #	Name	Size (Bits)	Description
7:5	Reserved	3	NA
4	Stuck_Key_RCV	1	1: Stuck key is recovered
3	Stuck_Key	1	1: Stuck key is detected
2	ADC_Change	1	1: ADC value change (when RAW data is enabled)
1	Reserved_Attach	1	1: Reserved device is attached
0	A/V_Charging	1	1: Charger detected when A/V cable is attached

**Table 11. Interrupt Mask 1**

- Address: 05h
- Reset Value: 00000000
- Type: Read/Write

Bit #	Name	Size (Bits)	Description
7	OVP_OCP_DIS	1	1: Mask OVP and OCP disabled interrupt
6	OCP_EN	1	1: Mask OCP enabled interrupt
5	OVP_EN	1	1: Mask OVP enabled interrupt
4	LKR	1	1: Mask long key release interrupt
3	LKP	1	1: Mask long key press interrupt
2	KP	1	1: Mask key press interrupt
1	Detach	1	1: Mask detach interrupt
0	Attach	1	1: Mask attach interrupt

**Table 12. Interrupt Mask 2**

- Address: 06h
- Reset Value: xxx00000
- Type: Read/Write

Bit #	Name	Size (Bits)	Description
7:5	Reserved	3	NA
4	Stuck_Key_RCV	1	1: Mask stuck key recovered interrupt
3	Stuck_Key	1	1: Mask stuck key Interrupt
2	ADC_Change	1	1: Mask ADC value change interrupt
1	Reserved_Attach	1	1: Mask reserved device interrupt
0	A/V_Charging	1	1: Mask charger detect when A/V cable attached interrupt

**Table 13. ADC**

- Address: 07h
- Reset Value: xxx11111
- Type: Read

Bit #	Name	Size (Bits)	Description
7:5	Reserved	3	NA
4:0	ADC Value	5	ADC value read from ID (see Table 2)

**Table 14. Timing Set 1**

- Address: 08h
- Reset Value: 00000100
- Type: Read/Write

Bit #	Name	Size (Bits)	Description
7:4	Key Press	4	Normal key press duration (see Table 16 — Timing Table for Timing Set 1 & 2 Registers)
3:0	ADC Detect Time	4	ADC detection time duration (see Table 16 — Timing Table for Timing Set 1 & 2 Registers)

**Table 15. Timing Set 2**

- Address: 09h
- Reset Value: 00000000
- Type: Read/Write

Bit #	Name	Size (Bits)	Description
7:4	Switching Wait	4	Waiting duration before switching (see Table 16 — Timing Table for Timing Set 1 & 2 Registers)
3:0	Long Key Press	4	Long key press duration (see Table 16 — Timing Table for Timing Set 1 & 2 Registers)

**Table 16. Timing Table for Timing Set 1 & 2 Registers**

Setting Value <sup>(19)</sup>	ADC Detection Time by Capacitive Load Register		Key Press Register	Long Key Press Register	Switching Wait Register
	Time	Max Capacitive Load ID Pin <sup>(20)</sup>			
0000	50ms	128pF	100ms	300ms	10ms
0001	100ms	256pF	200ms	400ms	30ms
0010	150ms	384pF	300ms	500ms	50ms
0011	200ms	512pF	400ms	600ms	70ms
0100	300ms	640pF	500ms	700ms	90ms
0101	400ms	768pF	600ms	800ms	110ms
0110	500ms	896pF	700ms	900ms	130ms
0111	600ms	1.02nF	800ms	1000ms	150ms
1000	700ms	1.15nF	900ms	1100ms	170ms
1001	800ms	1.28nF	1000ms	1200ms	190ms
1010	900ms	1.41nF		1300ms	210ms
1011	1000ms	1.54nF		1400ms	
1100				1500ms	
1101-1111					

**Notes:**

19. Each of the four registers can have unique register setting values.  
 20. Maximum capacitive load indicates the maximum load seen by the FSA9480 on the ID pin during accessory detection. Default setting for Rev 3.1 Silicon is 0100 for a 640pF load.

**Table 17. Device Type 1**

- Address: 0Ah
- Reset Value: 00000000
- Type: Read

Bit #	Name	Size (Bits)	Description
7	USB OTG	1	1: USB OTG device detected
6	Dedicated_Charger	1	1: Dedicated charger detected
5	USB_Charger	1	1: USB charger detected
4	Car Kit	1	1: Car kit detected
3	UART	1	1: UART detected
2	USB	1	1: USB detected
1	Audio Type 2	1	1: Audio device type 2 detected
0	Audio Type 1	1	1: Audio device type 1 detected

**Table 18. Device Type 2**

- Address: 0Bh
- Reset Value: x0000000
- Type: Read

Bit #	Name	Size (Bits)	Description
7	Reserved	1	NA
6	A/V	1	1: A/V cable detected
5	TTY	1	1: TTY detected
4	PPD	1	1: Phone-powered device detected
3	JIG_UART_OFF	1	1: Factory mode cable detected (JIG_UART_OFF)
2	JIG_UART_ON	1	1: Factory mode cable detected (JIG_UART_ON)
1	JIG_USB_OFF	1	1: Factory mode cable detected (JIG_USB_OFF)
0	JIG_USB_ON	1	1: Factory mode cable detected (JIG_USB_ON)

**Table 19. Button 1**

- Address: 0Ch
- Reset Value: 00000000
- Type: Read

Bit #	Name	Size (Bits)	Description
7	Button 7	1	1: Button 7 key press
6	Button 6	1	1: Button 6 key press
5	Button 5	1	1: Button 5 key press
4	Button 4	1	1: Button 4 key press
3	Button 3	1	1: Button 3 key press
2	Button 2	1	1: Button 2 key press
1	Button 1	1	1: Button 1 key press
0	Send_End	1	1: Send_End key press

**Table 20. Button 2**

- Address: 0Dh
- Reset Value: x0000000
- Type: Read

Bit #	Name	Size (Bits)	Description
7	Reserved	1	NA
6	Unknown	1	1: Unknown key press
5	Error	1	1: Error key press
4	Button 12	1	1: Button 12 key press
3	Button 11	1	1: Button 11 key press
2	Button 10	1	1: Button 10 key press
1	Button 9	1	1: Button 9 key press
0	Button 8	1	1: Button 8 key press

**Table 21. Car Kit Status**

- Address: 0Eh
- Reset Value: x0000100
- Type: Read/Write

Bit #	Name	Size (Bits)	Description
7	Reserved	1	NA
6	Disc_Request	1	0: Car kit disconnect not requested 1: Car kit disconnect requested
5	UART_Traffic	1	0: UART traffic disabled 1: UART traffic enabled
4:2	Mode	3	Car Kit Mode change <sup>(21)</sup> 000: Open all car kit switch paths 001: UART 010: Mono audio 011: Stereo audio 100: DDA enabled mono audio 101: DDA enabled stereo audio
1:0	Type	2	Detected car kit types 00: No connection 01: Car kit 10: Car kit charger type 1 11: Car kit charger type 2

**Note:**

21. Audio device type 2 also uses MODE 000, 001, 100, and 101 commands to change device modes.

**Table 22. Car Kit Interrupt 1**

- Address: 0Fh
- Reset Value: 00000000
- Type: Read/Clear

Bit #	Name	Size (Bits)	Description
7	CR_UART	1	1: Car kit generated interrupt during UART state
6	PH_Disc	1	1: Car kit state machine in disconnect state
5	PH_DDA_Stereo	1	1: Car kit state machine in DDA stereo state
4	PH_DDA_Mono	1	1: Car kit state machine in DDA mono state
3	PH_Aud_Stereo	1	1: Car kit state machine in stereo state
2	PH_Aud_Mono	1	1: Car kit state machine in mono state
1	PH_UART	1	1: Car kit state machine in UART state
0	PH_Int	1	1: Car kit state machine in initial state

**Table 23. Car Kit Interrupt 2**

- Address: 10h
- Reset Value: xxxxx000
- Type: Read/Clear

Bit #	Name	Size (Bits)	Description
7:3	Reserved	5	NA
2	CR_DDA_Stereo	1	1: Car kit generated interrupt during DDA stereo state
1	CR_Stereo	1	1: Car kit generated interrupt during stereo state
0	CR_Mono	1	1: Car kit generated interrupt during mono state

**Table 24. Car Kit Interrupt Mask 1**

- Address: 11h
- Reset Value: 00000000
- Type: Read/Write

Bit #	Name	Size (Bits)	Description
7	CR_UART	1	0: Unmask car kit UART interrupt 1: Mask car kit UART interrupt
6	PH_Disc	1	0: Unmask PH_Disc interrupt 1: Mask PH_Disc interrupt
5	PH_DDA_Stereo	1	0: Unmask PH_DDA_Stereo interrupt 1: Mask PH_DDA_Stereo interrupt
4	PH_DDA_Mono	1	0: Unmask PH_DDA_Mono interrupt 1: Mask PH_DDA_Mono interrupt
3	PH_Aud_Stereo	1	0: Unmask PH_Aud_Stereo interrupt 1: Mask PH_Aud_Stereo interrupt
2	PH_Aud_Mono	1	0: Unmask PH_Aud_Mono interrupt 1: Mask PH_Aud_Mono interrupt
1	PH_UART	1	0: Unmask PH_UART interrupt 1: Mask PH_UART interrupt
0	PH_Int	1	0: Unmask PH_Int interrupt 1: Mask PH_Int interrupt

**Table 25. Car Kit Interrupt Mask 2**

- Address: 12h
- Reset Value: xxxxx000
- Type: Read/Write

Bit #	Name	Size (Bits)	Description
7:3	Reserved	5	NA
2	CR_DDA_Stereo	1	0: Unmask CR_DDA_Stereo interrupt 1: Mask CR_DDA_Stereo interrupt
1	CR_Stereo	1	0: Unmask CR_Stereo interrupt 1: Mask CR_Stereo interrupt
0	CR_Mono	1	0: Unmask CR_Mono interrupt 1: Mask CR_Mono interrupt

**Table 26. Manual S/W 1**

- Address: 13h
- Reset Value: 00000000
- Type: Read/Write

Bit #	Name	Size (Bits)	Description
7:5	D- Switching	3	000: Open all switches 001: D- connected to D- of USB port 010: D- connected to Audio_L 011: D- connected to TxD of UART 100: D- connected to V_Audio_L
4:2	D+ Switching	3	000: Open all switches 001: D+ connected to D+ of USB port 010: D+ connected to Audio_R 011: D+ connected to RxD of UART 100: D+ connected to V_Audio_R
1:0	V <sub>BUS</sub> Switching <sup>(22)</sup>	2	00: Open all switches 01: V <sub>BUS</sub> connected to charger 10: V <sub>BUS</sub> connected to MIC

**Note:**

22. V<sub>BUS</sub> must be present to allow for signaling in manual USB path configuration.

**Table 27. Manual S/W 2**

- Address: 14h
- Reset Value: XXX00000
- Type: Read/Write

Bit #	Name	Size (Bits)	Description
7:4	Reserved	4	NA
3	BOOT_SW	1	0: LOW 1: HIGH
2	JIG_ON	1	0: High Impedance 1: GND
1:0	ID Switching	2	00: Open all switches 01: ID connected to video 10: ID connected to bypass port

## Physical Dimensions

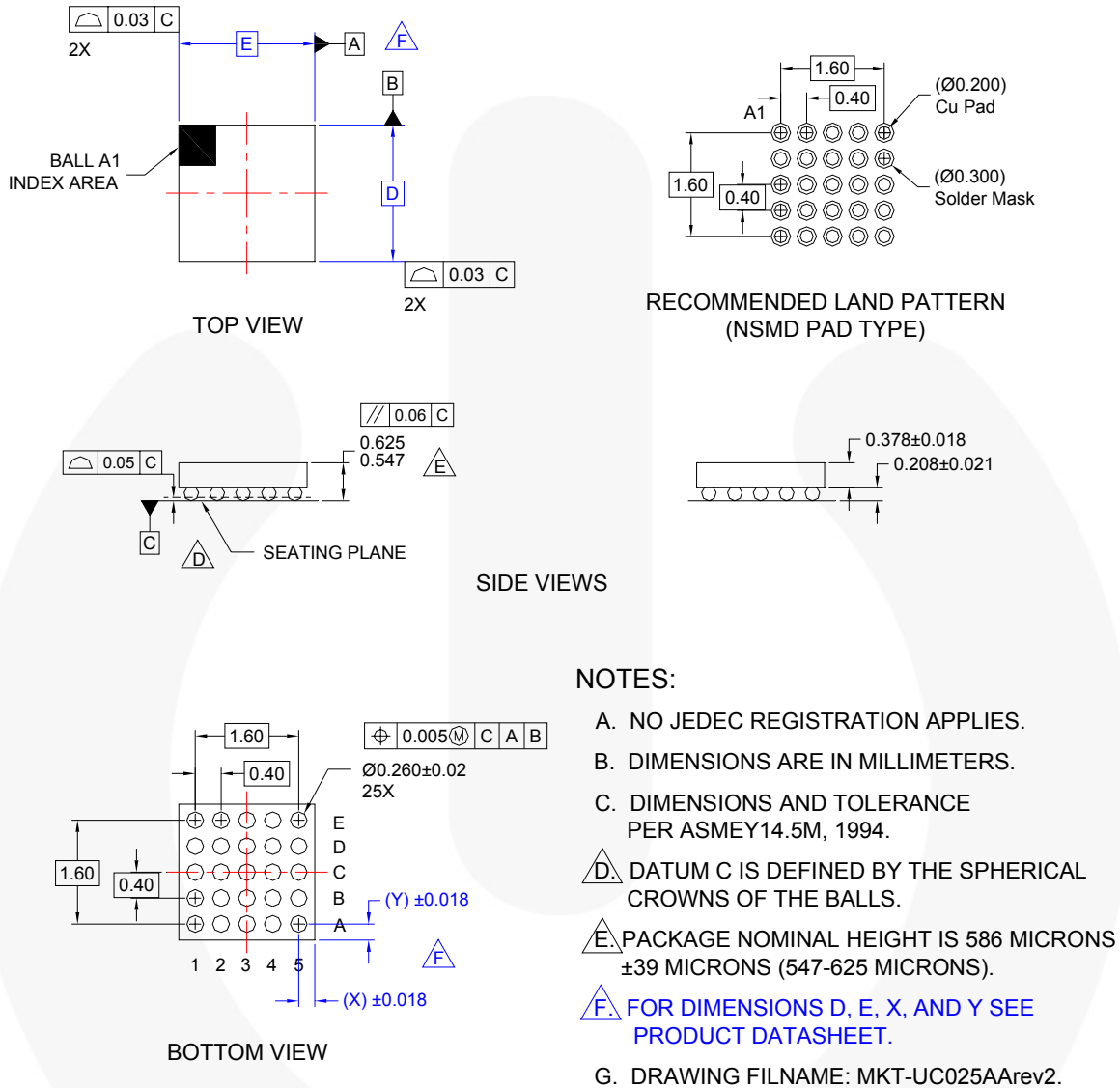

**Figure 21. 25-Lead, Wafer-Level Chip-Scale Package (WLCSP)**

## Product-Specific Dimensions

Product	D	E	X	Y
FSA9480UCX	2.10	2.10	0.25	0.25

Package drawings are provided as a service to customers considering Fairchild components. Drawings may change in any manner without notice. Please note the revision and/or date on the drawing and contact a Fairchild Semiconductor representative to verify or obtain the most recent revision. Package specifications do not expand the terms of Fairchild's worldwide terms and conditions, specifically the warranty therein, which covers Fairchild products.

Always visit Fairchild Semiconductor's online packaging area for the most recent package drawings:  
<http://www.fairchildsemi.com/packaging/>



## Tape and Reel Specifications

### FSA9480UCX Packing - Embossed Tape



**Packing Description:**

FSA9480UCX, a WLCSP product, is classified under Moisture Sensitive Level 1 and is packed in moisture barrier bag for added protection.

The carrier tape is made from dissipative polystyrene or polycarbonate resin. The cover tape is a multilayer film primarily composed of polyester film, adhesive layer, heat activated sealant, and anti-static sprayed agent. These reeled parts in standard option are shipped with 3000 units per 178 mm diameter reel. Up to three reels are packed in each intermediate box. The reels is made of polystyrene plastic (anti-static coated or intrinsic).

These full reels are individually barcode labeled and placed inside a pizza box made of recyclable corrugated brown paper with a Fairchild logo printing. The reel is packed single reel in the pizza box. And these pizza boxes are placed inside a barcode labeled shipping box which comes in different sizes depending on the number of parts shipped.

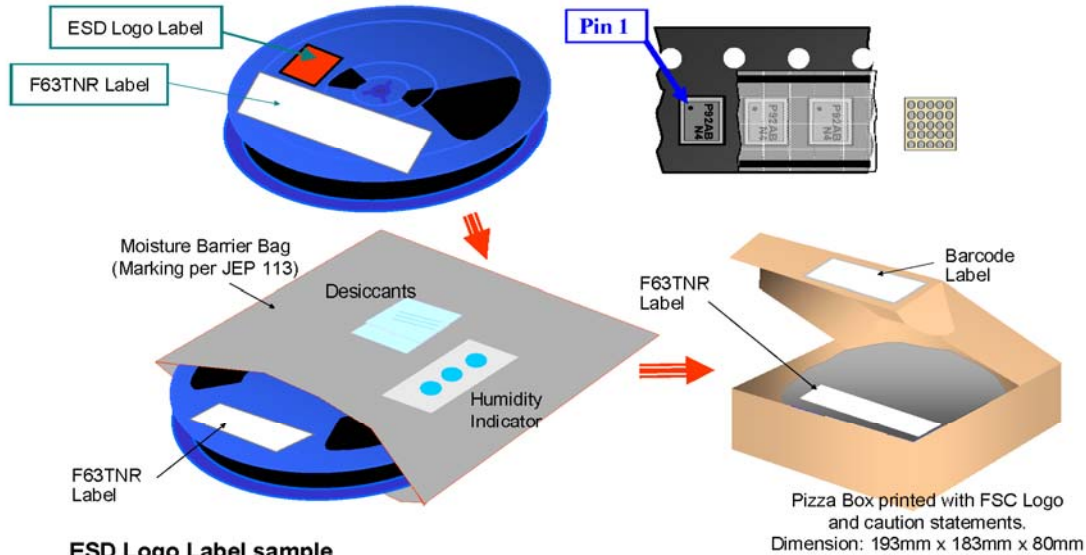

**ESD Logo Label sample**



**F63TNR Label sample**

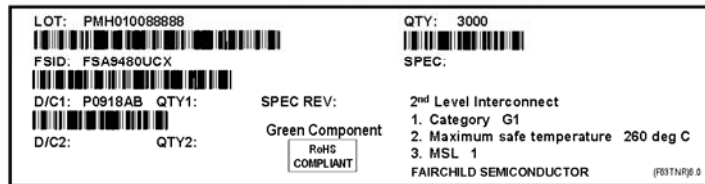

**Tape Leader and Trailer Configuration**

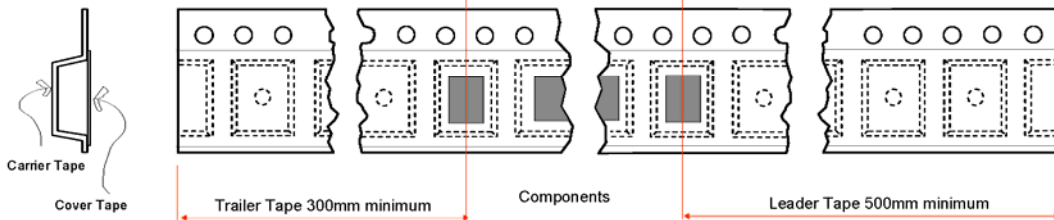

Rev 2 090304

## Tape and Reel Specifications (Continued)

### FSA9480UCX Embossed Tape Dimension

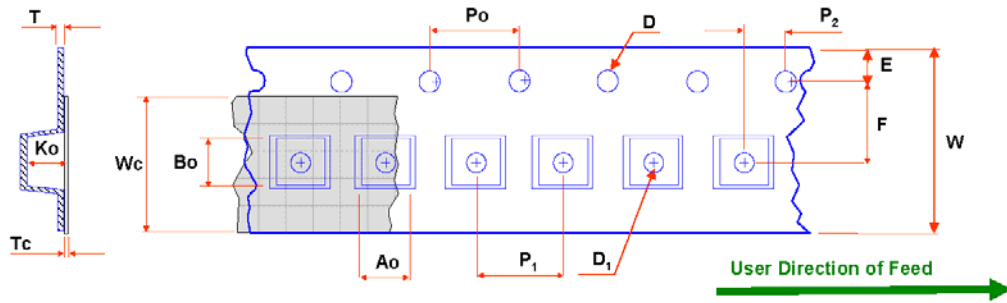

Dimensions are in millimeters

Package	Ao +/-0.10	Bo +/-0.10	D +/-0.05	D1 min.	E +/-0.1	F +/-0.1	Ko +/-0.1	P1 TYP	Po TYP	P2 +/-0.05	T TYP	Tc +/-0.005	W +/-0.3	Wc TYP
FRF1003A	2.35	2.35	1.55	0.5	1.75	3.5	0.81	4	4	2.0	0.254	0.06	8	5.3

Notes: Ao, Bo, and Ko dimensions are determined with respect to the EIA /Jedec RS-481 rotational and lateral movement requirements (see sketches A, B, and C).

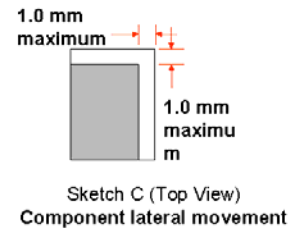
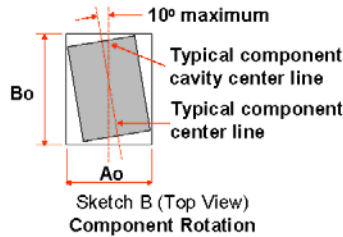
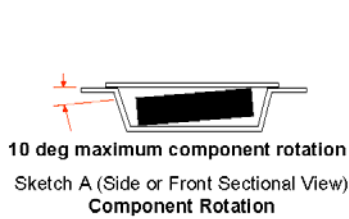

### Shipping Reel Dimension

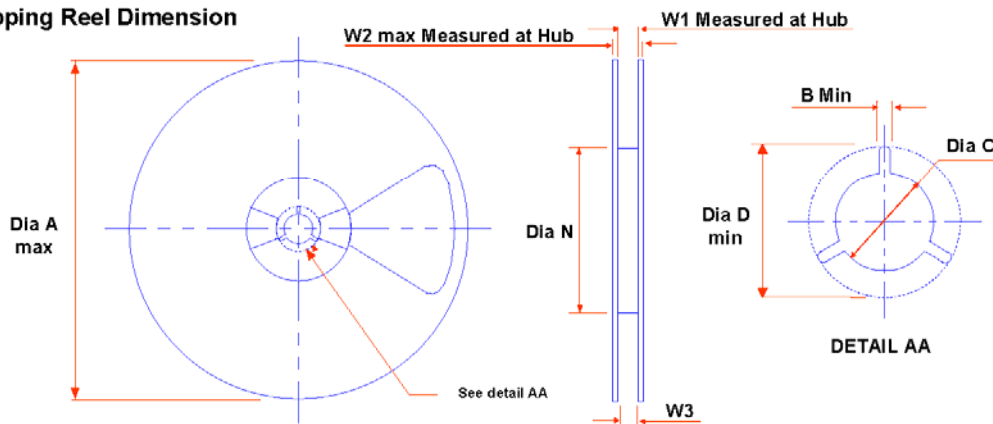

Dimensions are in millimeters







Tape Width	Dia A max	Dim B min	Dia C +5/-2	Dia D min	Dim N min	Dim W1 +2/-0	Dim W2 max	Dim W3 (LSL - USL)
8	178	1.5	13	20.2	55	8.4	14.4	7.9~10.4

Rev 2 090304



**TRADEMARKS**

The following includes registered and unregistered trademarks and service marks, owned by Fairchild Semiconductor and/or its global subsidiaries, and is not intended to be an exhaustive list of all such trademarks.

- |   |   |   |   |
|---|---|---|---|
| AccuPower™  | F-PFS™  | Power-SPM™  | <br><b>SYSTEM GENERAL</b> <sup>®*</sup><br>The Power Franchise <sup>®</sup><br><br><b>power franchise</b><br>TinyBoost™<br>TinyBuck™<br>TinyCalc™<br>TinyLogic™<br>TINYOPTO™<br>TinyPower™<br>TinyPWM™<br>TinyWire™<br>TriFault Detect™<br>TRUECURRENT™*<br><br><b>SerDes</b> <sup>®</sup><br>UHC™<br>Ultra FRFET™<br>UniFET™<br>VCX™<br>VisualMax™<br>XS™ |
| Auto-SPM™   | FRFET®  | PowerTrench®  |   |
| Build it Now™   | Global Power Resource <sup>SM</sup>   | PowerXS™  |   |
| CorePLUS™   | Green FPS™  | Programmable Active Droop™  |   |
| CorePOWER™  | Green FPST™ e-Series™   | QFET®   |   |
| CROSSVOLT™  | Gmax™   | QS™   |   |
| CTL™  | GTO™  | Quiet Series™   |   |
| Current Transfer Logic™   | IntelliMAX™   | RapidConfigure™   |   |
| DEUXPEED®   | ISOPLANAR™  |  ™ |   |
| Dual Cool™  | MegaBuck™   | Saving our world, 1mW/W/kW at a time™   |   |
| EcoSPARK®   | MICROCOUPLER™   | SignalWise™   |   |
| EfficientMax™   | MicroFET™   | SmartMax™   |   |
| ESBCT™  | MicroPak™   | SMART START™  |   |
|  ™ | MicroPak2™  | SPM®  |   |
| Fairchild®  | MillerDrive™  | STEALTH™  |   |
| Fairchild Semiconductor®  | MotionMax™  | SuperFET™   |   |
| FACT Quiet Series™  | Motion-SPM™   | SuperSOT™.3   |   |
| FACT®   | OptoHIT™  | SuperSOT™.6   |   |
| FAST®   | OPTOLOGIC®  | SuperSOT™.8   |   |
| FastvCore™  | OPTOPLANAR®   | SupreMOS®   |   |
| FETBench™   |  ™ | SyncFET™  |   |
| FlashWriter <sup>®*</sup>   | PDP SPM™  | Sync-Lock™  |   |
| FPS™  |   |   |   |

\* Trademarks of System General Corporation, used under license by Fairchild Semiconductor.

**DISCLAIMER**

FAIRCHILD SEMICONDUCTOR RESERVES THE RIGHT TO MAKE CHANGES WITHOUT FURTHER NOTICE TO ANY PRODUCTS HEREIN TO IMPROVE RELIABILITY, FUNCTION, OR DESIGN. FAIRCHILD DOES NOT ASSUME ANY LIABILITY ARISING OUT OF THE APPLICATION OR USE OF ANY PRODUCT OR CIRCUIT DESCRIBED HEREIN; NEITHER DOES IT CONVEY ANY LICENSE UNDER ITS PATENT RIGHTS, NOR THE RIGHTS OF OTHERS. THESE SPECIFICATIONS DO NOT EXPAND THE TERMS OF FAIRCHILD'S WORLDWIDE TERMS AND CONDITIONS, SPECIFICALLY THE WARRANTY THEREIN, WHICH COVERS THESE PRODUCTS.

**LIFE SUPPORT POLICY**

FAIRCHILD'S PRODUCTS ARE NOT AUTHORIZED FOR USE AS CRITICAL COMPONENTS IN LIFE SUPPORT DEVICES OR SYSTEMS WITHOUT THE EXPRESS WRITTEN APPROVAL OF FAIRCHILD SEMICONDUCTOR CORPORATION.

As used herein:

1. Life support devices or systems are devices or systems which, (a) are intended for surgical implant into the body or (b) support or sustain life, and (c) whose failure to perform when properly used in accordance with instructions for use provided in the labeling, can be reasonably expected to result in a significant injury of the user.
2. A critical component in any component of a life support, device, or system whose failure to perform can be reasonably expected to cause the failure of the life support device or system, or to affect its safety or effectiveness.

**ANTI-COUNTERFEITING POLICY**

Fairchild Semiconductor Corporation's Anti-Counterfeiting Policy. Fairchild's Anti-Counterfeiting Policy is also stated on our external website, [www.fairchildsemi.com](http://www.fairchildsemi.com), under Sales Support.

Counterfeiting of semiconductor parts is a growing problem in the industry. All manufacturers of semiconductor products are experiencing counterfeiting of their parts. Customers who inadvertently purchase counterfeit parts experience many problems such as loss of brand reputation, substandard performance, failed applications, and increased cost of production and manufacturing delays. Fairchild is taking strong measures to protect ourselves and our customers from the proliferation of counterfeit parts. Fairchild strongly encourages customers to purchase Fairchild parts either directly from Fairchild or from Authorized Fairchild Distributors who are listed by country on our web page cited above. Products customers buy either from Fairchild directly or from Authorized Fairchild Distributors are genuine parts, have full traceability, meet Fairchild's quality standards for handling and storage and provide access to Fairchild's full range of up-to-date technical and product information. Fairchild and our Authorized Distributors will stand behind all warranties and will appropriately address any warranty issues that may arise. Fairchild will not provide any warranty coverage or other assistance for parts bought from Unauthorized Sources. Fairchild is committed to combat this global problem and encourage our customers to do their part in stopping this practice by buying direct or from authorized distributors.

**PRODUCT STATUS DEFINITIONS**

**Definition of Terms**

Datasheet Identification	Product Status	Definition
Advance Information	Formative / In Design	Datasheet contains the design specifications for product development. Specifications may change in any manner without notice.
Preliminary	First Production	Datasheet contains preliminary data; supplementary data will be published at a later date. Fairchild Semiconductor reserves the right to make changes at any time without notice to improve design.
No Identification Needed	Full Production	Datasheet contains final specifications. Fairchild Semiconductor reserves the right to make changes at any time without notice to improve the design.
Obsolete	Not In Production	Datasheet contains specifications on a product that is discontinued by Fairchild Semiconductor. The datasheet is for reference information only.

Rev. 149